

TREVIL®

The new Trevistar CR

Moves according to the real shape of shirts.

Designed to be ergonomic
and easy for the operator.

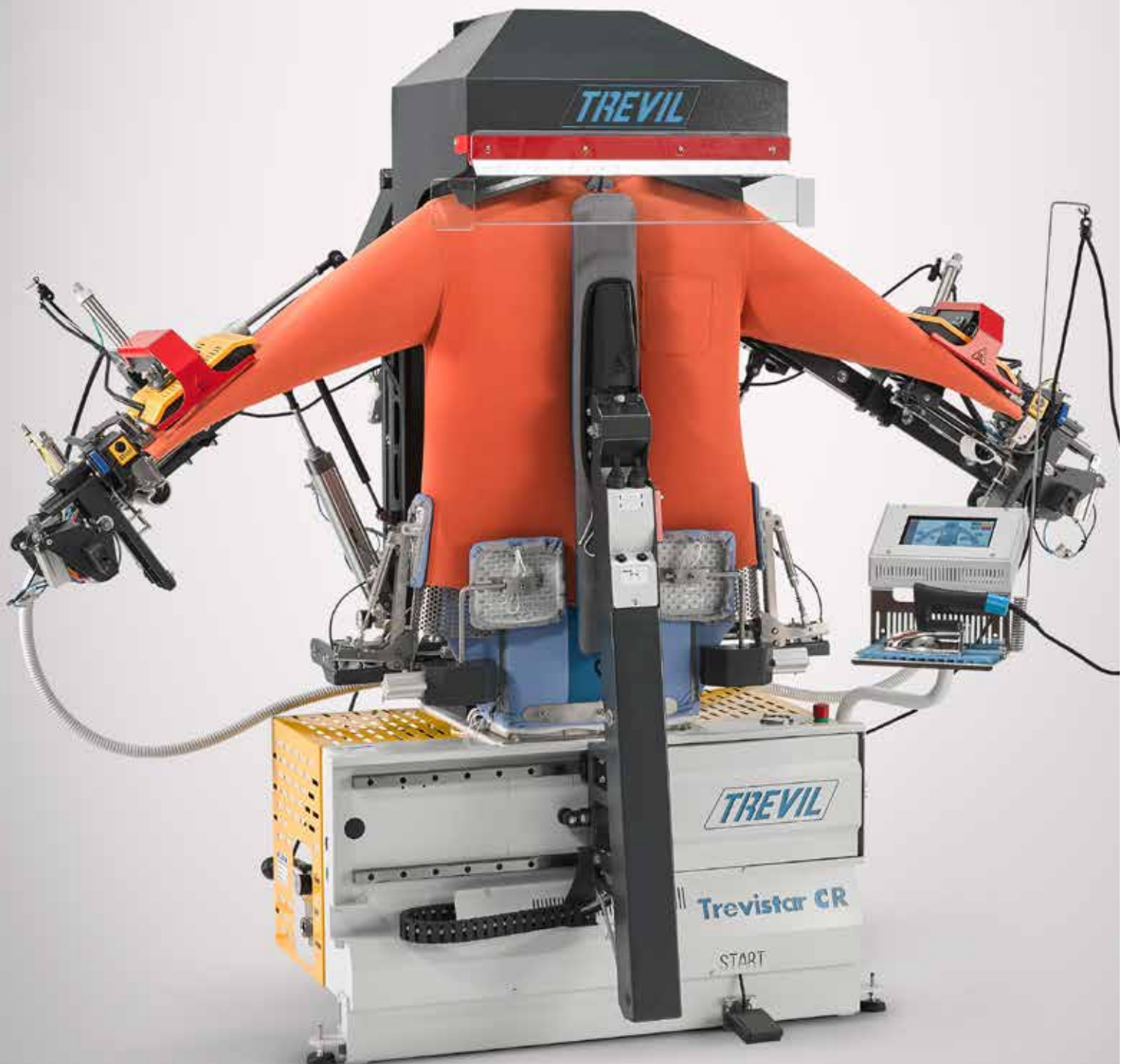

Trevistar CR

Placket presses

Choose FC-type sleeve clamps for a crisp finish of both pleats and plackets.

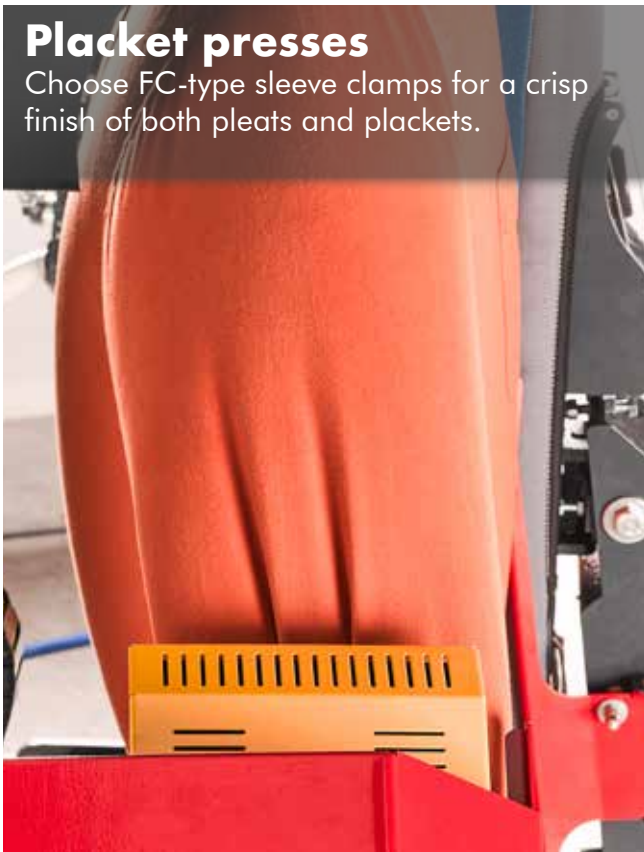

Touch-up iron

Accurate and lightweight.

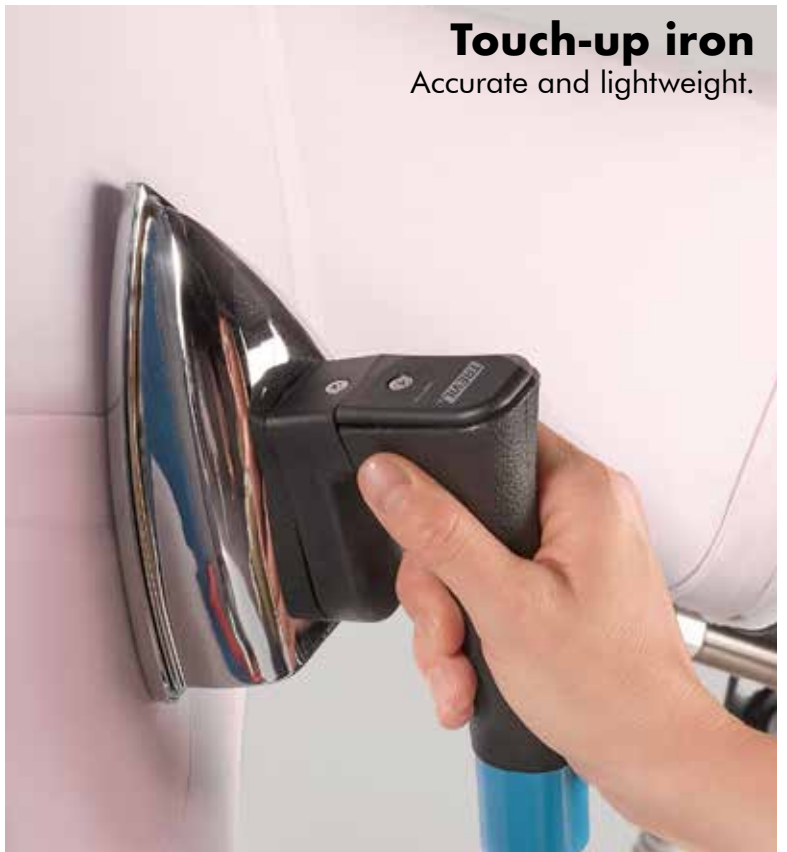

Easy maintenance & troubleshooting

Check the status of vital components in no time through windows in the cabinet. Read pop-up messages that remind routine maintenance and report anomalies on the console.

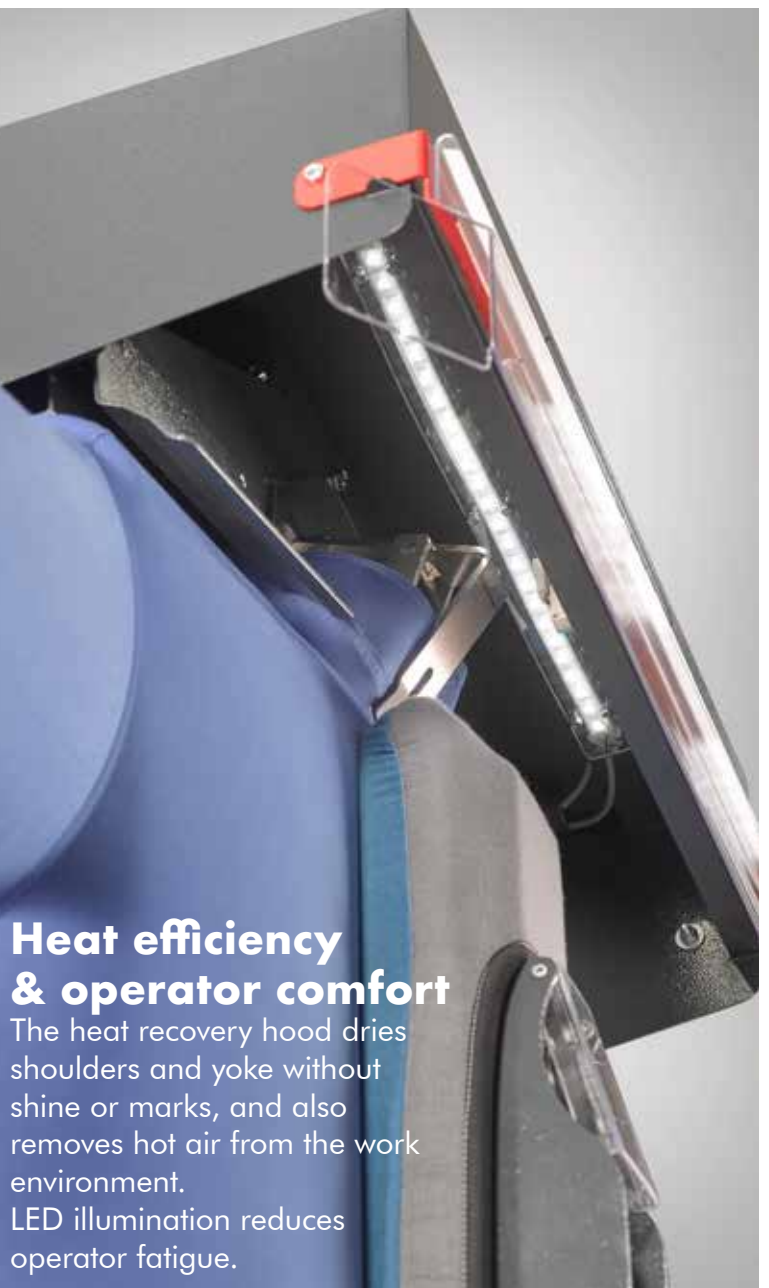

Heat efficiency & operator comfort

The heat recovery hood dries shoulders and yoke without shine or marks, and also removes hot air from the work environment. LED illumination reduces operator fatigue.

47-60 cm (18"-23")

42-55 cm (16"-21")

Two sizes of form available

A standard size for men's shirts and a narrow buck for tapered shirts and ladies' blouses.



With FC-type sleeve clamps

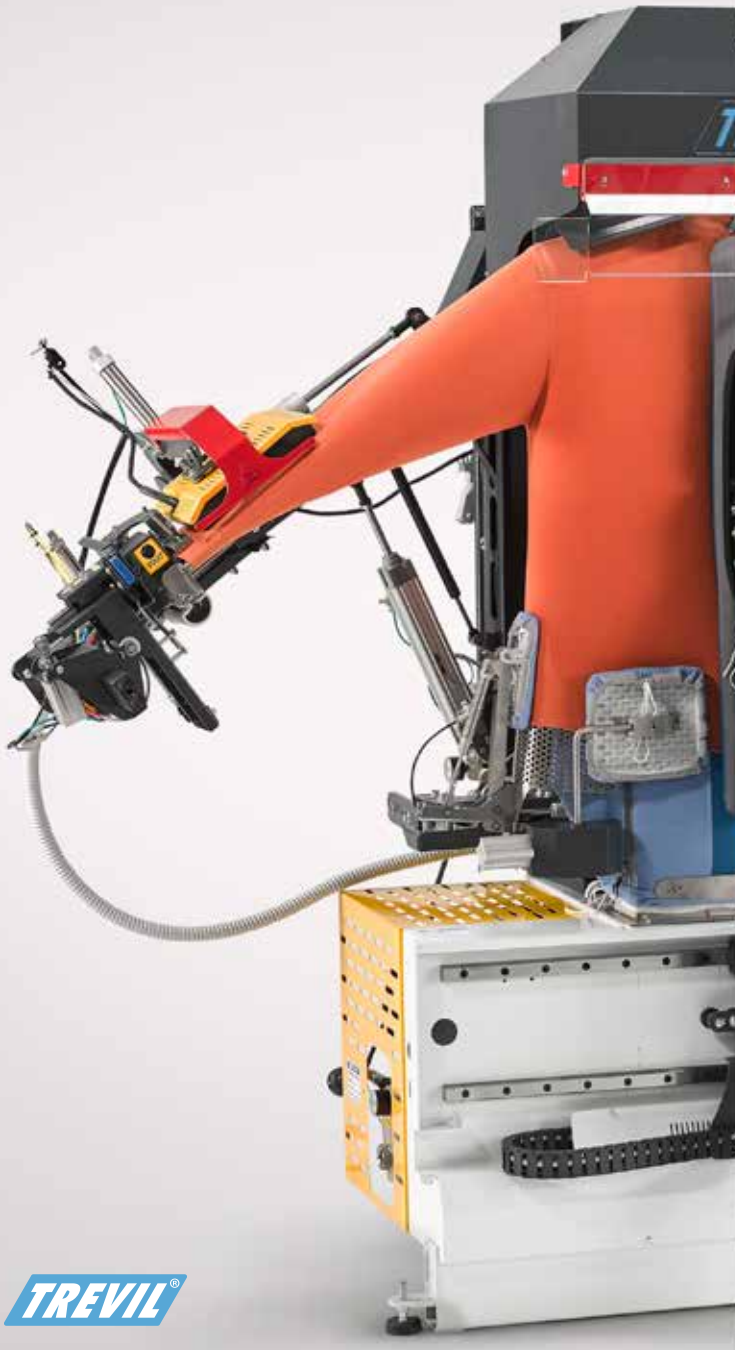

With S-type sleeve clamps

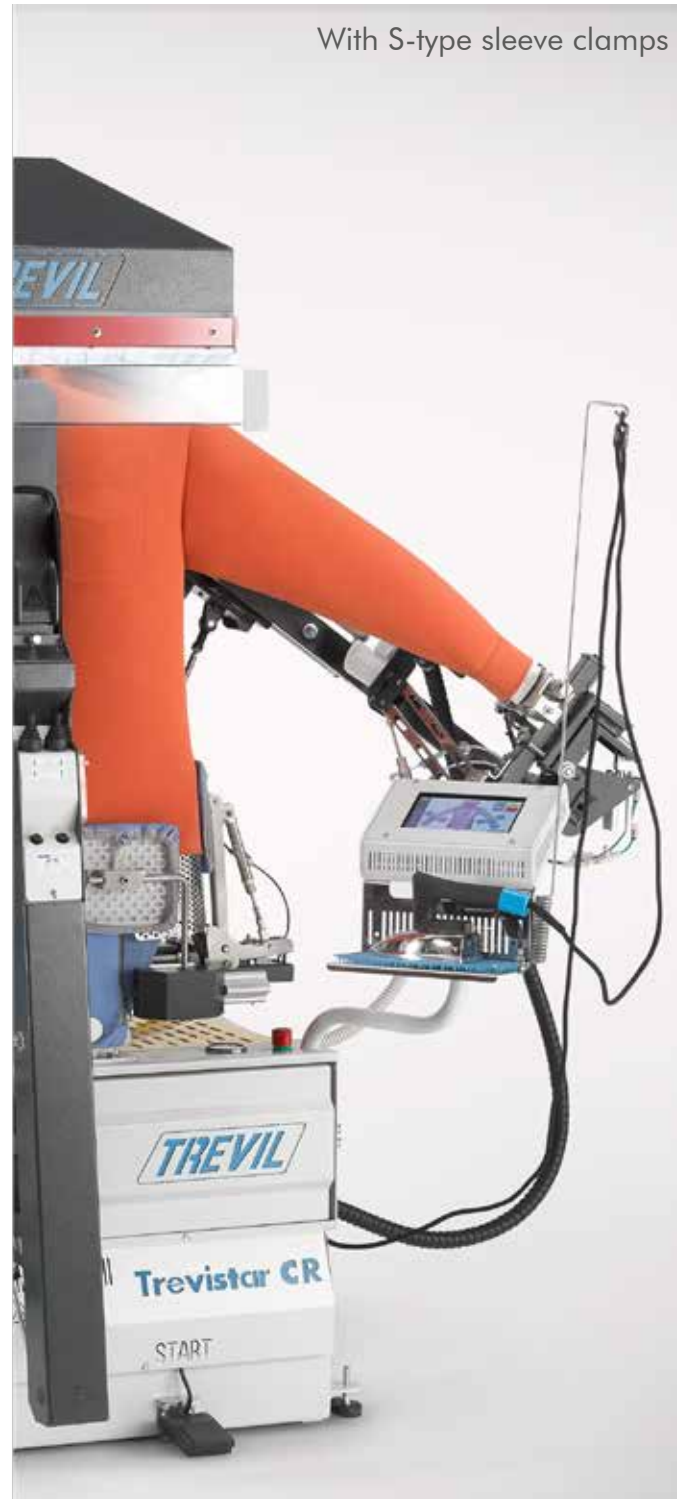

TREVIL

Contactless placket finishing

Choose S-type sleeve clamps for a softly natural finish, without unwanted marks.



Built-in short sleeve clamps

Both FC- and S-type sleeve clamps provide a rounded finish of short sleeves. Precise tensioning control avoids distortions and overstretching.



One pedal operation

Do not waste your time looking for controls.

New SMART interface

Super simple operation and complete control of tensioning at your fingertips.



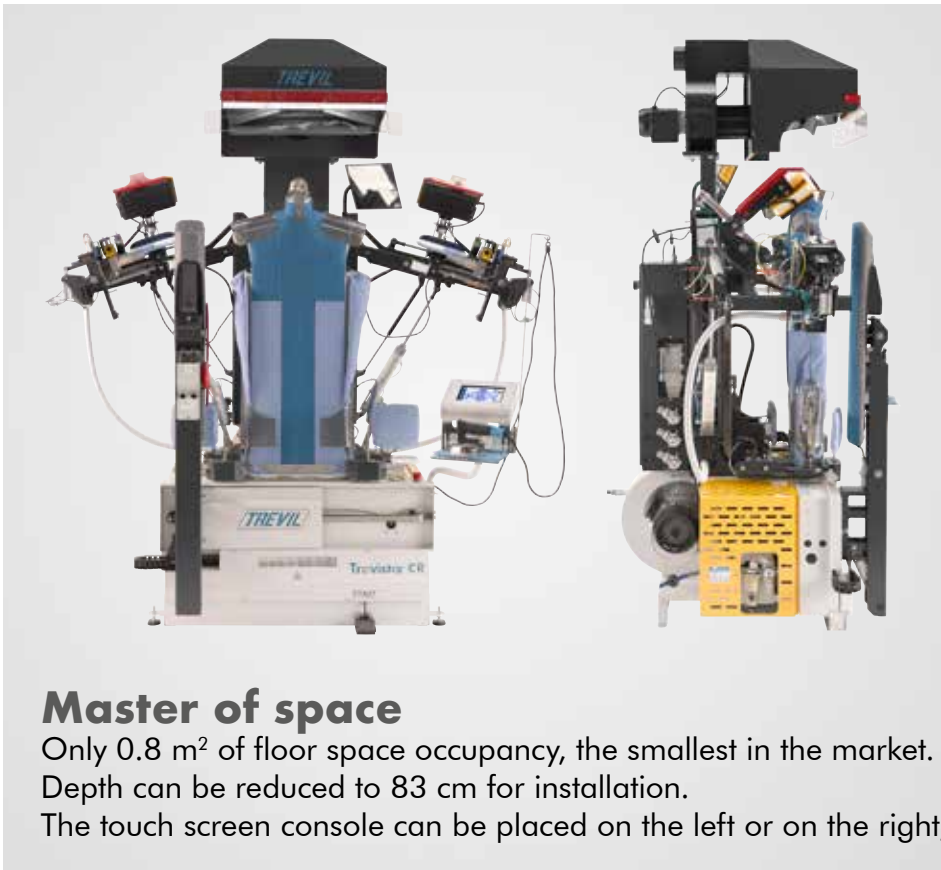

Master of space

Only 0.8 m² of floor space occupancy, the smallest in the market.
 Depth can be reduced to 83 cm for installation.
 The touch screen console can be placed on the left or on the right, according to store layout.



Convenient

Temperature control of the front clamp with protection against accidental change. Main adjustments available also on the front clamp.



Big saver

The Economizer, available upon request, reduces steam consumption and increases productivity.

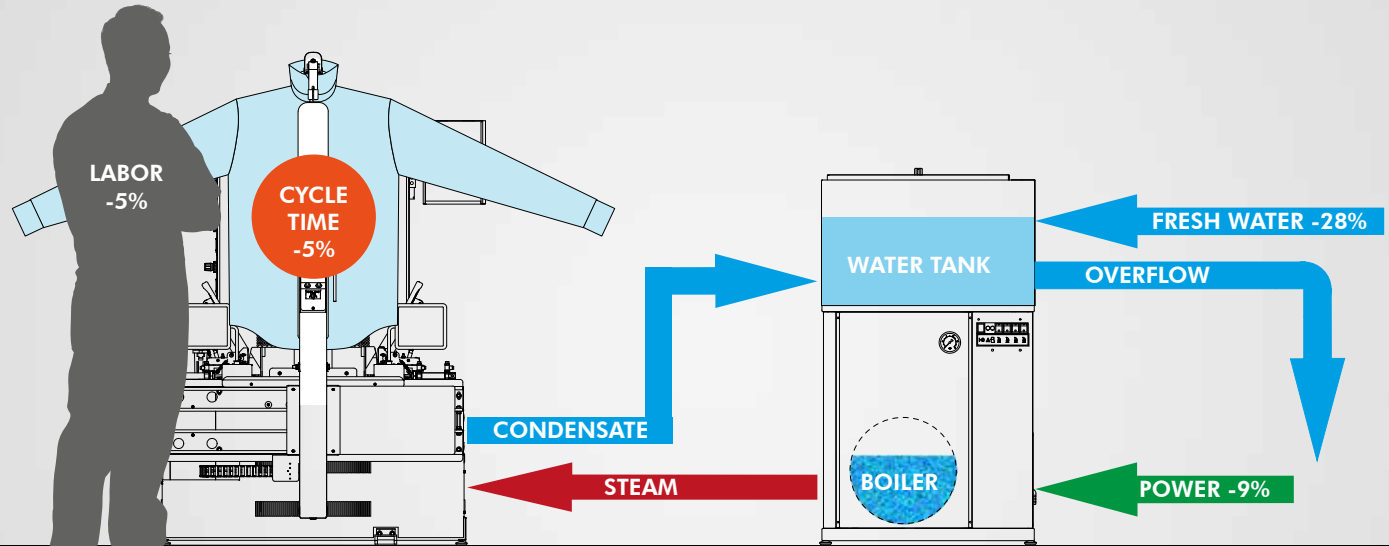

Electric boiler with condensate recovery tank

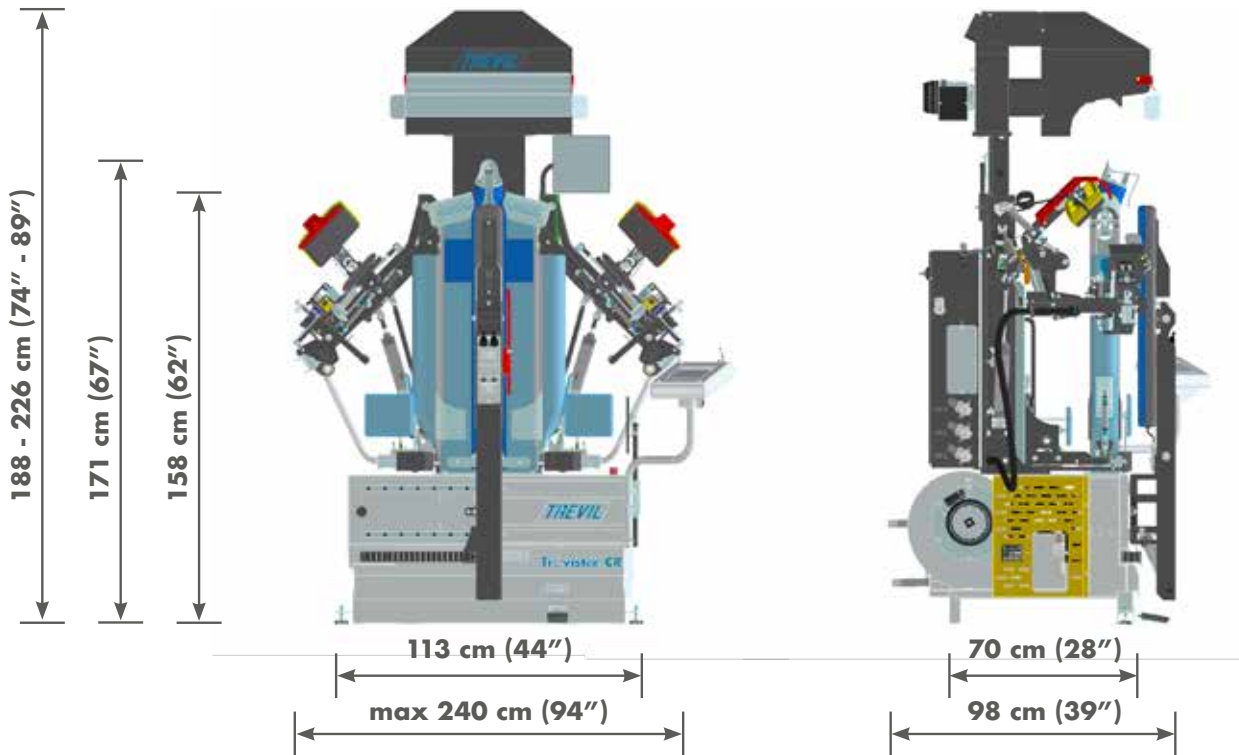

Available models

- 5280 - Regular buck and blown finish of pleats & placket
- 5281 - Narrow buck and blown finish of pleats & placket
- 5282 - Regular buck and pressed finish of pleats & placket
- 5283 - Narrow buck and pressed finish of pleats & placket

TECHNICAL SPECS	DATI TECNICI	DATOS TECNICOS	DONEES TECHNIQUES	TECHNISCHE DATEN	5280, 5281	5282, 5283
Electrical requirements*	Alimentazione elettrica*	Alimentación electrica*	Entrée courant*	Elektrischer Anschluss*	400V 3N 50Hz 220V 3 60Hz	
Power consumption	Potenza nominale	Potencia nominal	Puissance nominale	Nennleistung	3,7 kW	4,6 kW
. suction	. aspirazione	. aspirador	. aspirateur	. Absaugen	0,4 kW - 0.5 HP	
. blowing	. soffiaggio	. motor soplante	. soufflage	. Blasen	2,2 kW - 3 HP	
. front clamp	. pala frontale	. pala frontal	. pale frontale	. Vordere Andruckleiste	1 kW	
. FC clamps	. pinze mod FC				-	0,9 kW
Steam inlet	Entrata vapore	Entrada vapor	Entrée vapeur	Dampfeinlass	G 1/2"	
Condensate outlet	Uscita condensa	Salida condensación	Sortie de vapeur d'eau condensée	Kondensatauslass	G 1/2"	
Air inlet	Ingresso aria	Entrada de aire	Entrée d'air	Lufteinlass	G 1/4"	
Steam pressure	Pressione vapore	Presión vapor	Pression vapeur	Dampfdruck	800 kPa - 8 bar - 116 PSI	
Compressed air pressure	Pressione aria	Presión aire	Pression d'air	Druckluft	600 kPa - 6 bar - 87 PSI	
Dimensions	Dimensioni	Medidas	Dimensions	Abmessungen	113 (240 max)x98x226 cm 44" (94"max)x39"x89"	
Net weight	Peso netto	Peso neto	Poids net	Nettogewicht	330 kg	340 kg
* Others available	* Altri a richiesta	* Otros por encargo	* Autres sur demande	* Andere auf Anfrage		
Subject to modification without notice	Con riserva di modifica senza preavviso	Con reserva de modificación sin previo aviso	Sous réserve de modification sans préavis	Änderungen vorbehalten		



Trevil s.r.l.
Via Copernico, 1 - 20060 Pozzo d'Adda (MI) - Italy
Tel. +39 02 9093141 - www.trevil.com - info@trevil.com